

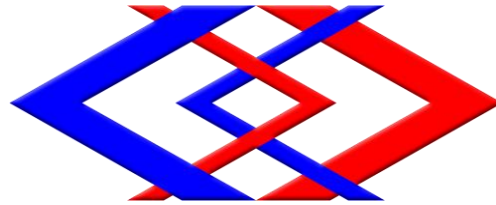

MRT Purple Line Project, Bang Yai - Bang Sue Section
Mass Rapid Transit Authority of Thailand, Ministry of Transport



MRT PURPLE LINE PROJECT BANG YAI TO BANG SUE SECTION

WELCOME OF KYOTO UNIVERSITY
ALUMNI

12 Feb 2011, Mandarin hotel



MRT Purple Line Project, Bang Yai – Bang Sue Section
Mass Rapid Transit Authority of Thailand, Ministry of Transport



SESSION 1: GENERAL INTRODUCTION





MRT Purple Line Project, Bang Yai – Bang Sue Section
Mass Rapid Transit Authority of Thailand, Ministry of Transport



1. EXISTING LINES

T. EXISTING LINES



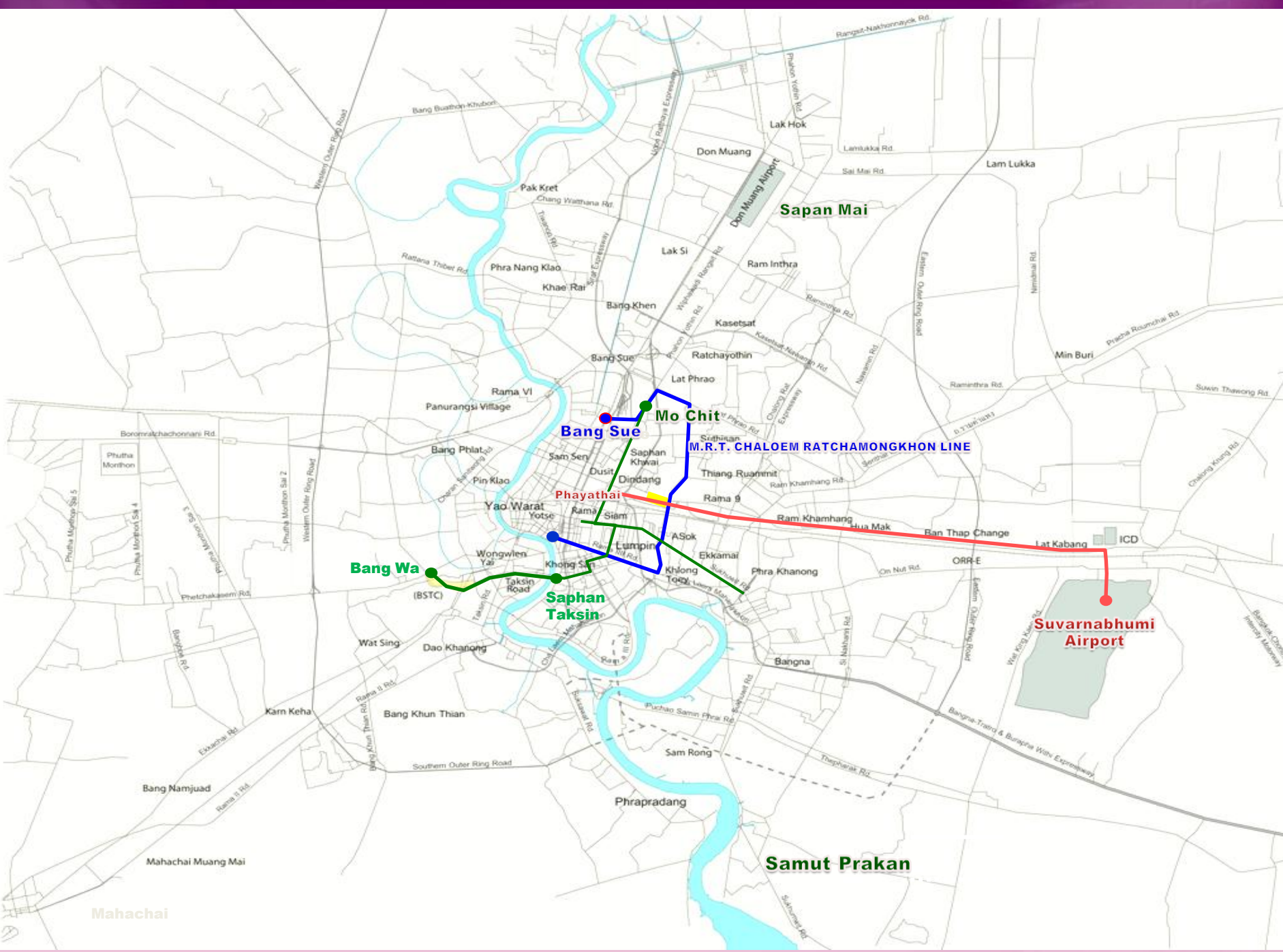

Sapan Mai

Mo Chit

Bang Sue

M.R.T. CHALERM RATCHAMONGKHON LINE

Phayathai

Bang Wa

Saphan Taksin

Suvarnabhumi Airport

Samut Prakan

Mahachai



MRT Purple Line Project, Bang Yai – Bang Sue Section
Mass Rapid Transit Authority of Thailand, Ministry of Transport



2. PURPLE LINE



Purple Line
Bang Yai-Bang Sue 23 km.

Bang Yai

Bang Bamru

Taling Chan

Bang Wa

Rat Burana

Bang Sue

Mo Chit

Phayathai

Saphan Taksin

Bearing

Sam Rong

Samut Prakan

Sapan Mai

Suvarnabhumi Airport

M.R.T. CHALOEM RATCHAMONGKHON LINE

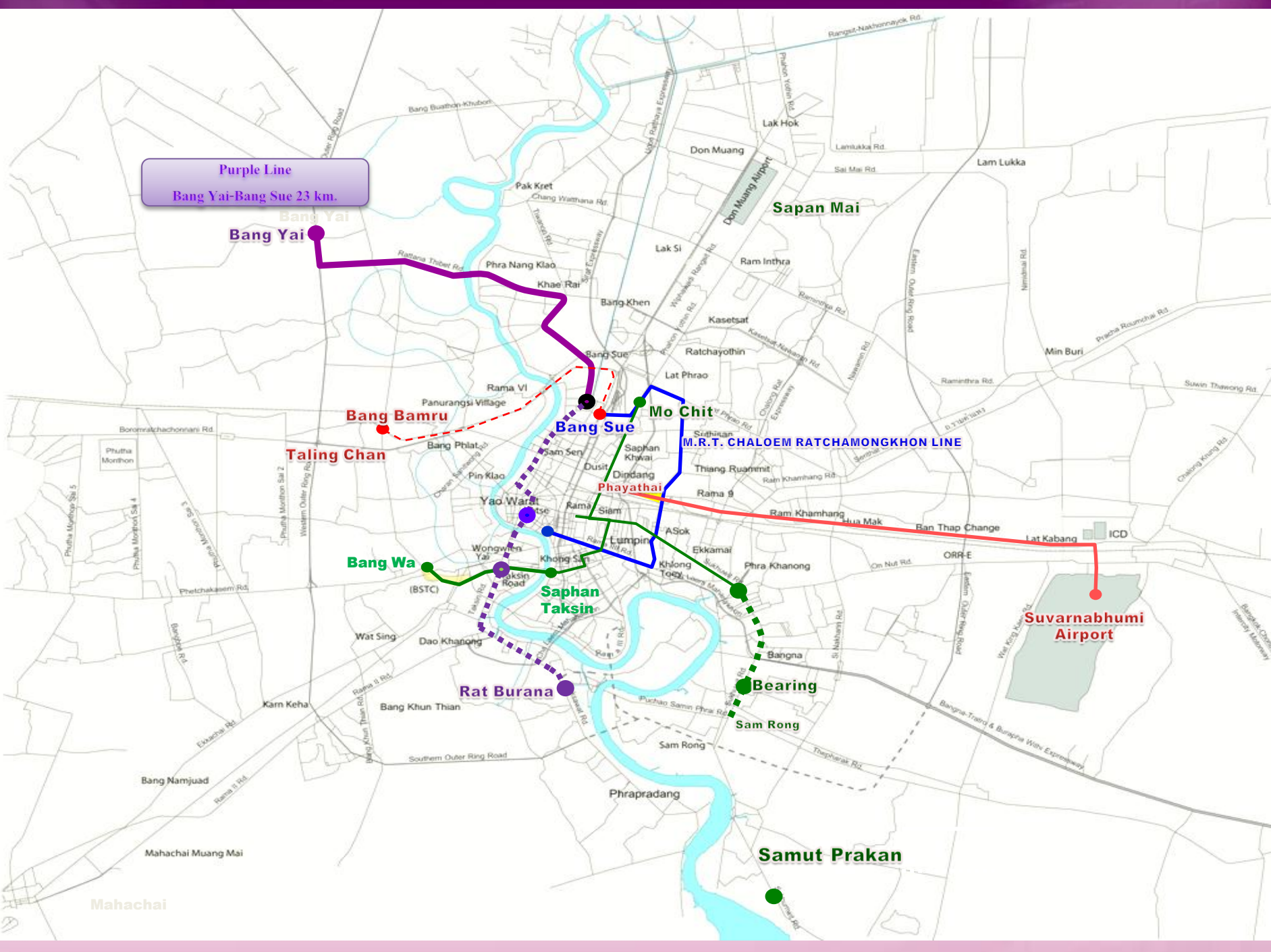



MRT Purple Line Project, Bang Yai – Bang Sue Section
Mass Rapid Transit Authority of Thailand, Ministry of Transport



3. OVERALL PURPLE LINE



Overall Purple Line





MRT Purple Line Project, Bang Yai – Bang Sue Section
Mass Rapid Transit Authority of Thailand, Ministry of Transport



4. ORDINARY STATION





MRT Purple Line Project, Bang Yai - Bang Sue Section
Mass Rapid Transit Authority of Thailand, Ministry of Transport



Yaek Tiwanon Station





MRT Purple Line Project, Bang Yai – Bang Sue Section
Mass Rapid Transit Authority of Thailand, Ministry of Transport



5. TAO POON STATION





MRT Purple Line Project, Bang Yai - Bang Sue Section

Mass Rapid Transit Authority of Thailand, Ministry of Transport





MRT Purple Line Project, Bang Yai – Bang Sue Section
Mass Rapid Transit Authority of Thailand, Ministry of Transport



6. PARK & RIDE BUILDING

PARK & RIDE BUILDING





MRT Purple Line Project, Bang Yai - Bang Sue Section
Mass Rapid Transit Authority of Thailand, Ministry of Transport



THA IT P&R (10 floors)

Capacity 1,100 cars

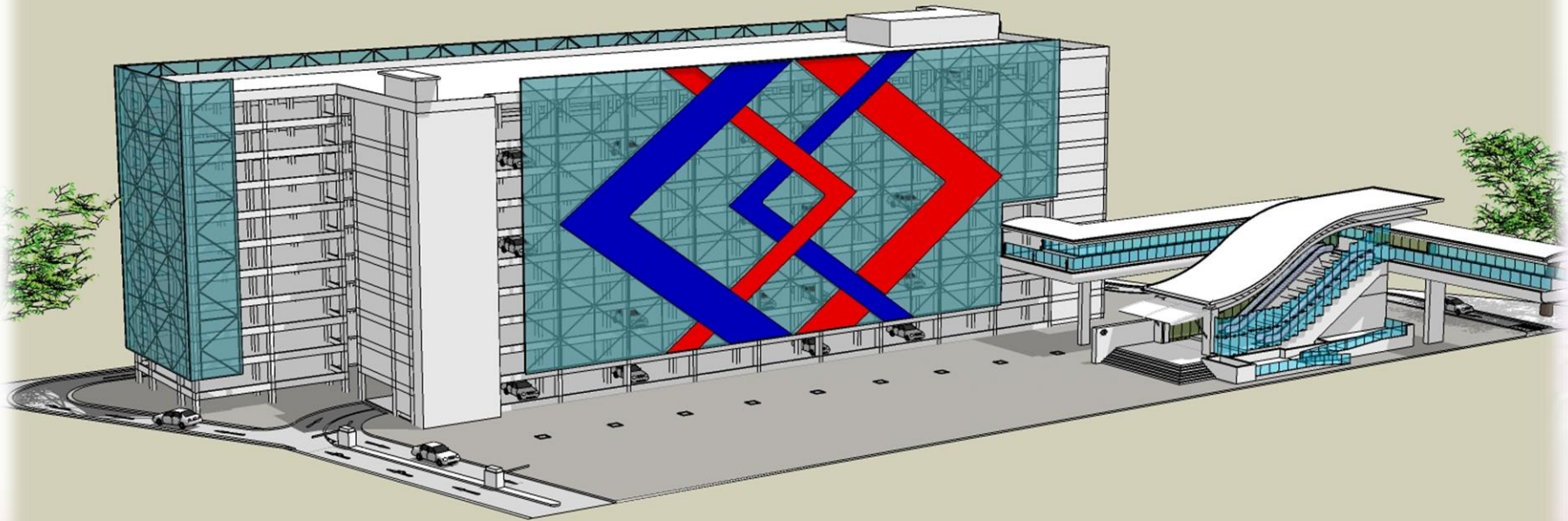



MRT Purple Line Project, Bang Yai – Bang Sue Section
Mass Rapid Transit Authority of Thailand, Ministry of Transport



7. FUTURE LINE



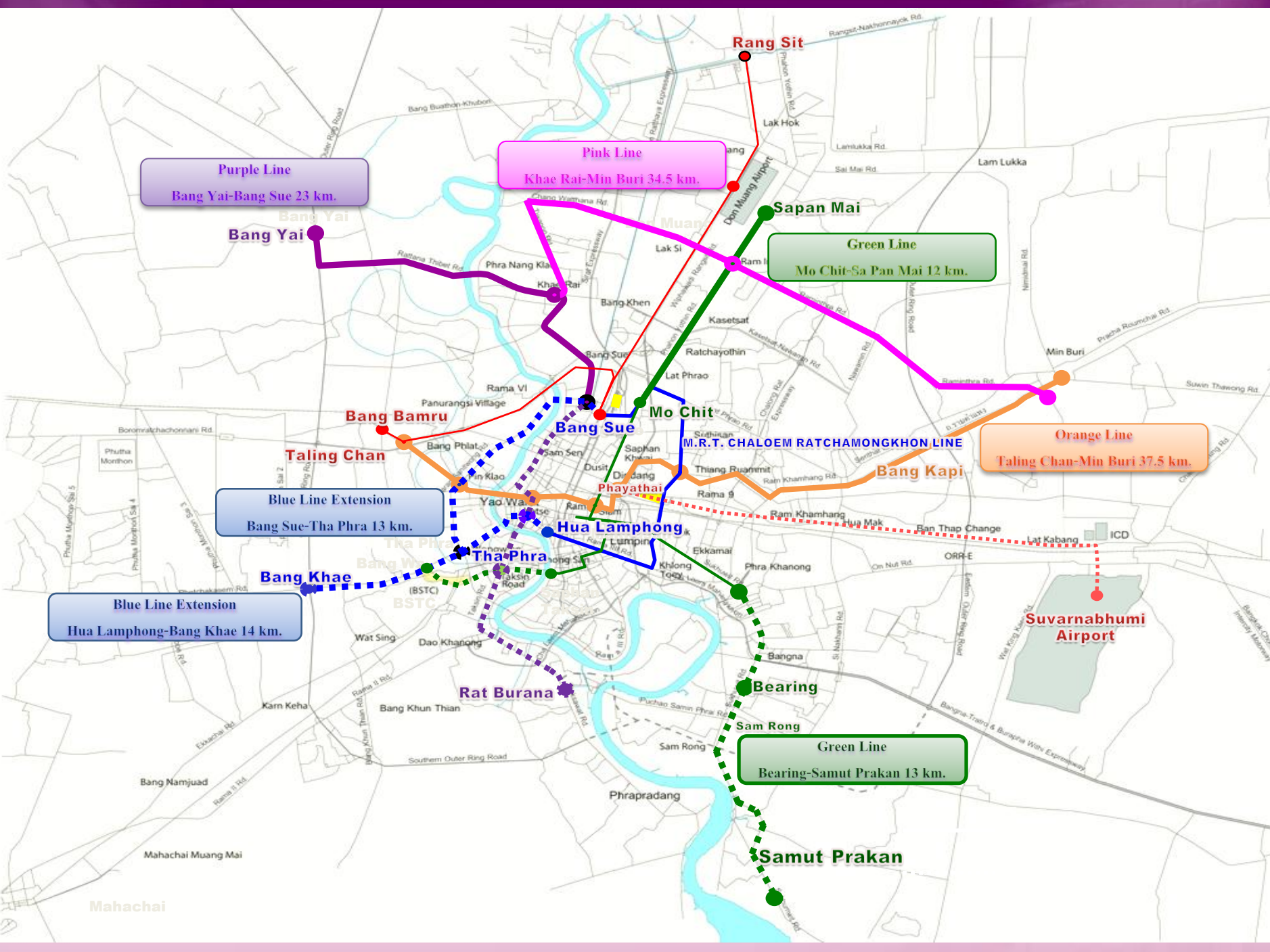

Purple Line
Bang Yai-Bang Sue 23 km.

Pink Line
Khae Rai-Min Buri 34.5 km.

Green Line
Mo Chit-Sa Pan Mai 12 km.

Orange Line
Taling Chan-Min Buri 37.5 km.

Blue Line Extension
Bang Sue-Tha Phra 13 km.

Blue Line Extension
Hua Lamphong-Bang Khae 14 km.

Green Line
Bearing-Samut Prakan 13 km.

M.R.T. CHALOEM RATCHAMONGKHON LINE

Suvarnabhumi Airport

Mahachai



MRT Purple Line Project, Bang Yai – Bang Sue Section
Mass Rapid Transit Authority of Thailand, Ministry of Transport



SESSION 2: VIADUCT





8. TYPICAL VIADUCT





MRT Purple Line Project, Bang Yai - Bang Sue Section
Mass Rapid Transit Authority of Thailand, Ministry of Transport



PERSPECTIVE VIEW





9. BARRETTE PILE (FOUNDATION)



Change to Barrette Pile Foundation

**CONVENTIONAL BORED PILE
FOUNDATION
(4 Nos. 15m. BORED PILE)**

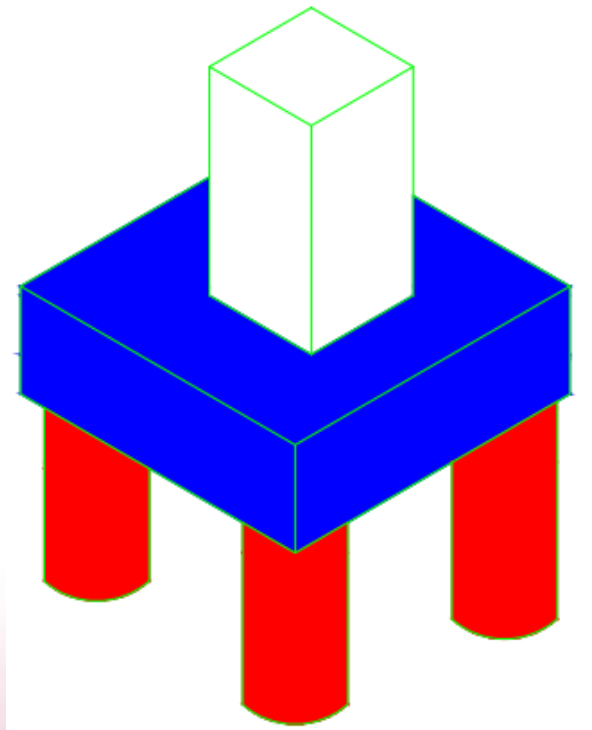

**BARRETTE PILE FOUNDATION
(2 Nos. 1.0x3.0m. BARRETTE PILE)**

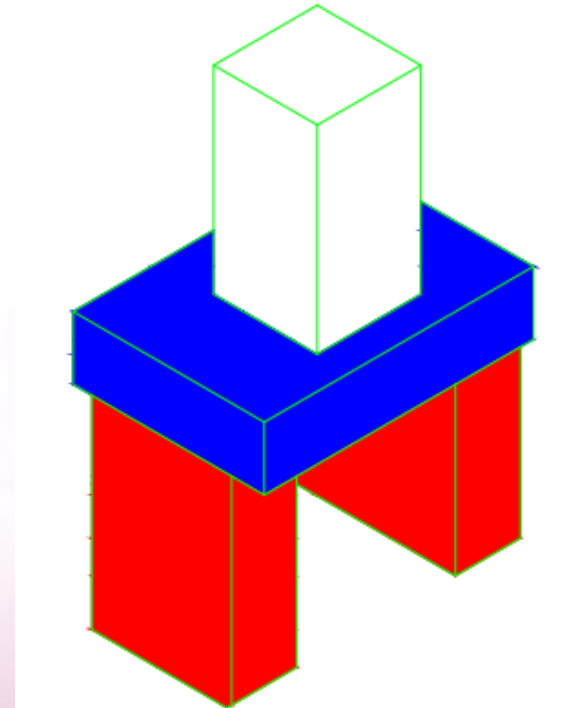

Advantage of Barrette Pile

**CONVENTIONAL BORED PILE
FOUNDATION
(4 Nos. 15m. BORED PILE)**

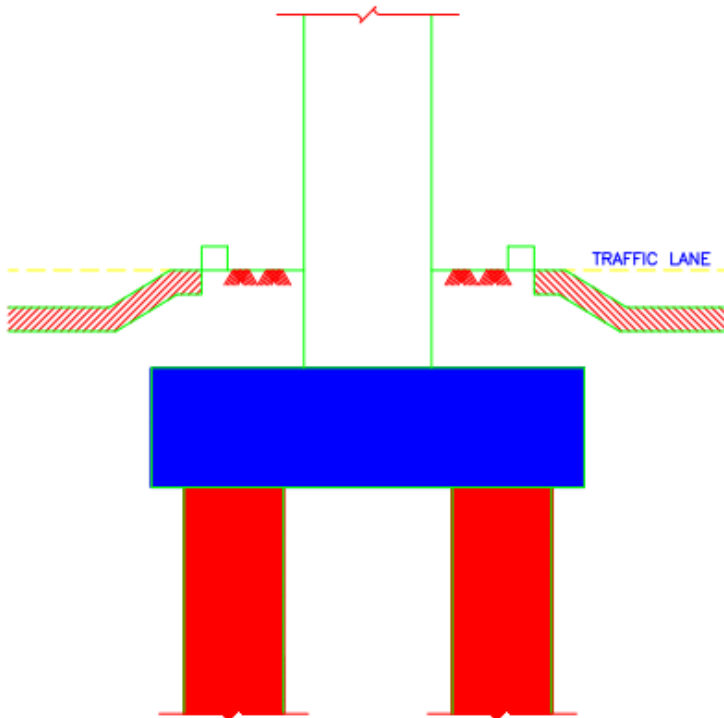

**BARRETTE PILE FOUNDATION
(2 Nos. 1.0x3.0m. BARRETTE PILE)**

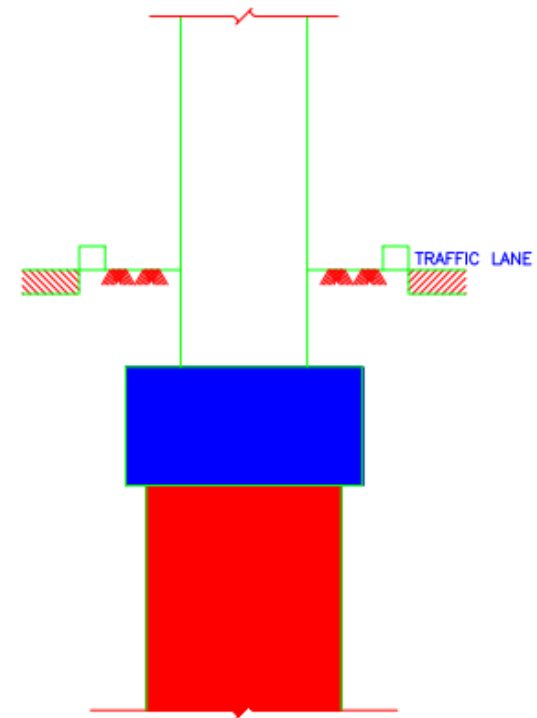



MRT Purple Line Project, Bang Yai – Bang Sue Section
Mass Rapid Transit Authority of Thailand, Ministry of Transport



10. SUPER STRUCTURE



What is Prestressed Concrete ?

Nature of concrete

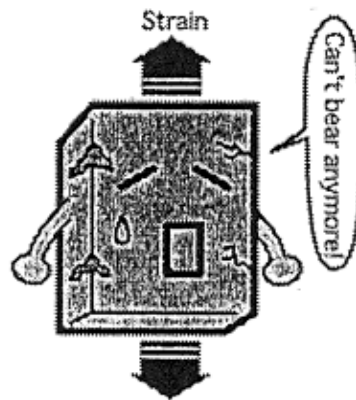
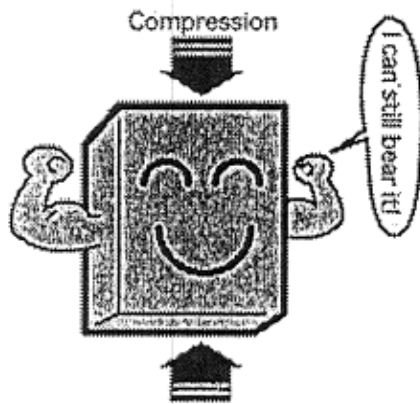



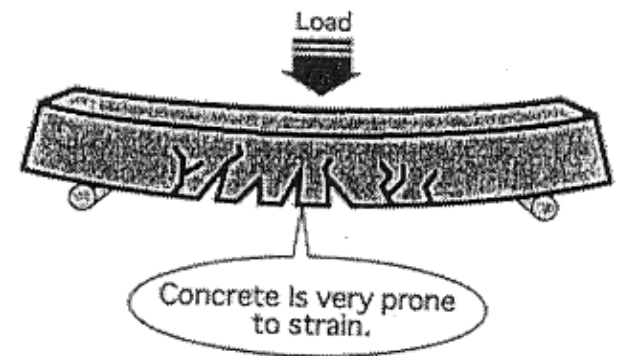

Plain concrete

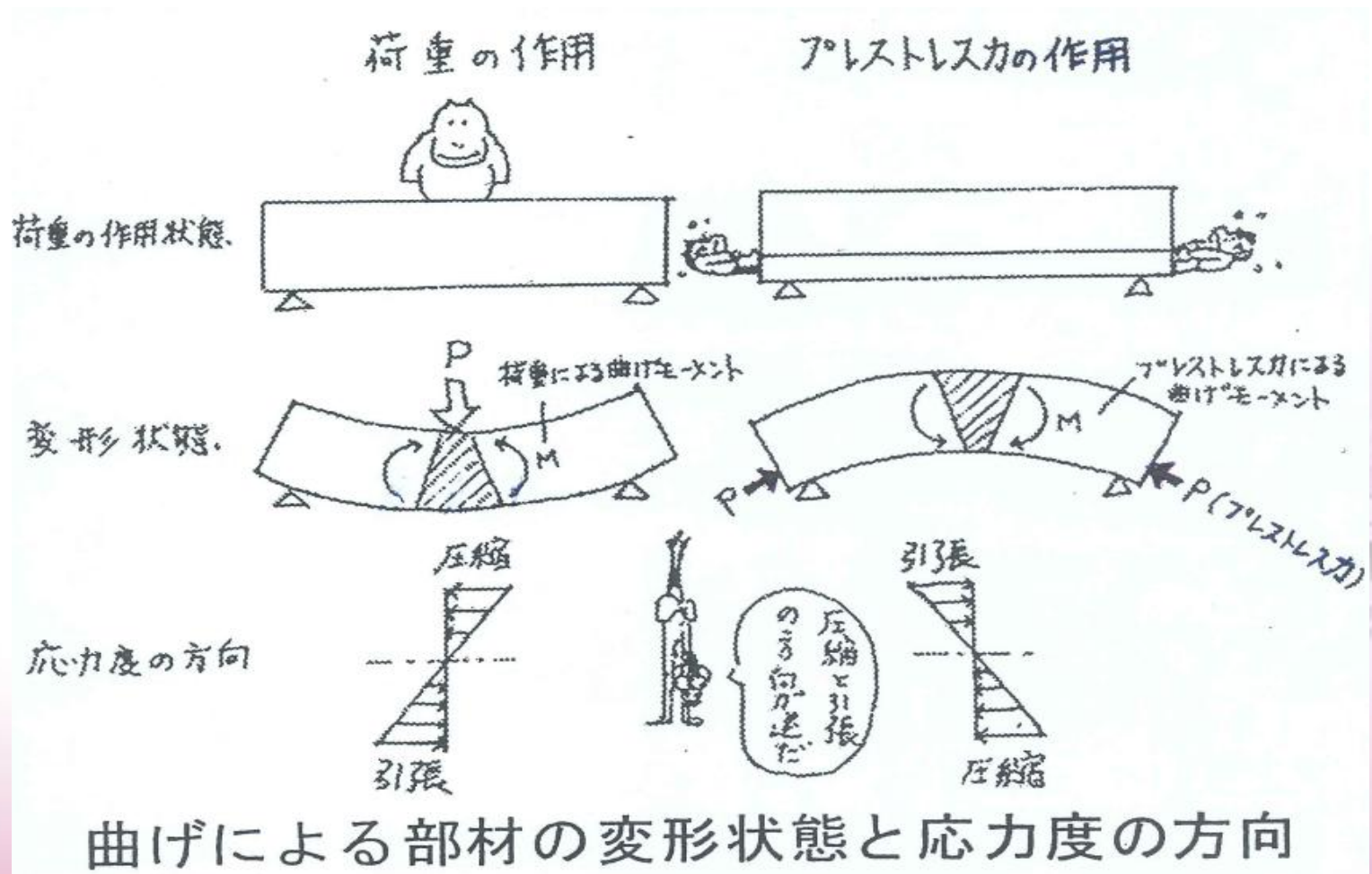

What is Prestressed Concrete ?

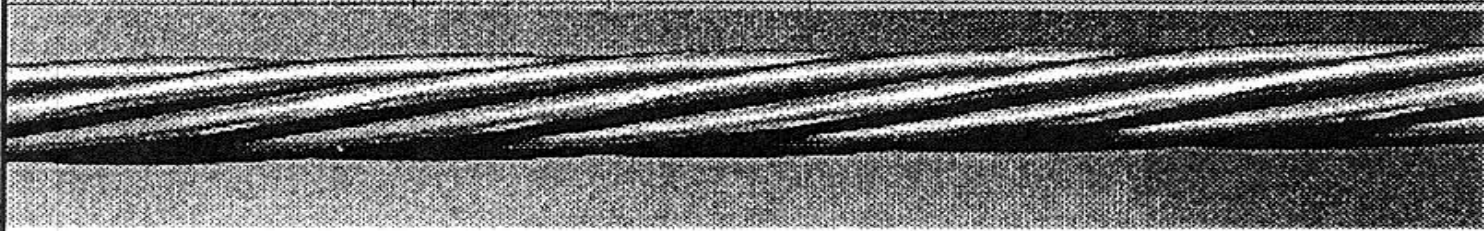

High Tensile Steel Tendon

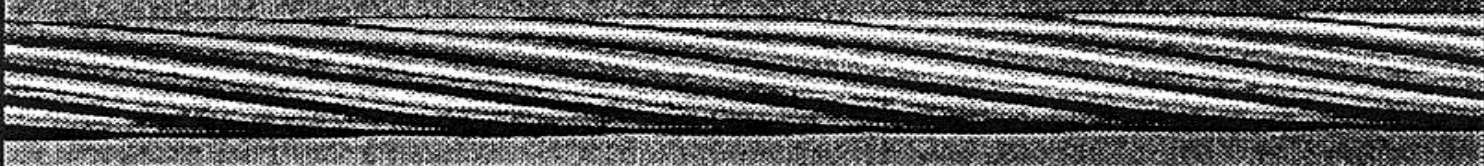
PC鋼より線				
	(mm)	(inch)	(形状)	
7本より	6.2~15.7	0.250~0.600		
				
19本より	17.8~21.8	0.700~0.860		
				

Segment fabrication at factory



Segment at storage



Segment transportation by rail



Segment transportation by Trailer





Segment erection

(Video Clip)





MRT Purple Line Project, Bang Yai – Bang Sue Section
Mass Rapid Transit Authority of Thailand, Ministry of Transport



SESSION 3: EARTHQUAKE



Against Earthquake ?

- 1, Design the structure against
“Appropriate Lateral Load”
- 2, Provide Seismic Buffer



Seismic Buffer

SEISMIC BUFFER

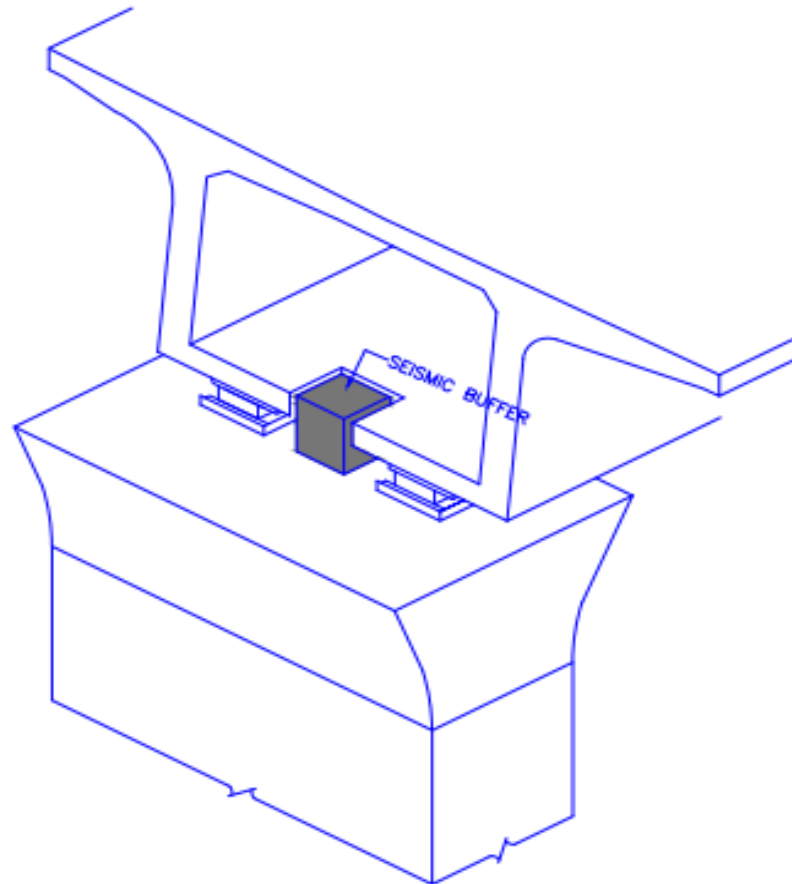

Against Earthquake ?

Further more, for Purple Line,

3, Continuous Viaduct Structure

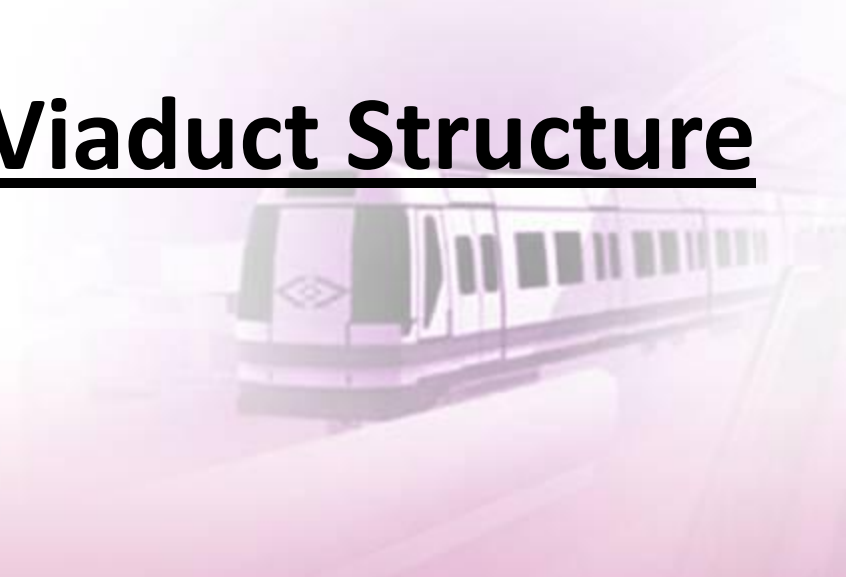

Continuous Viaduct Structure

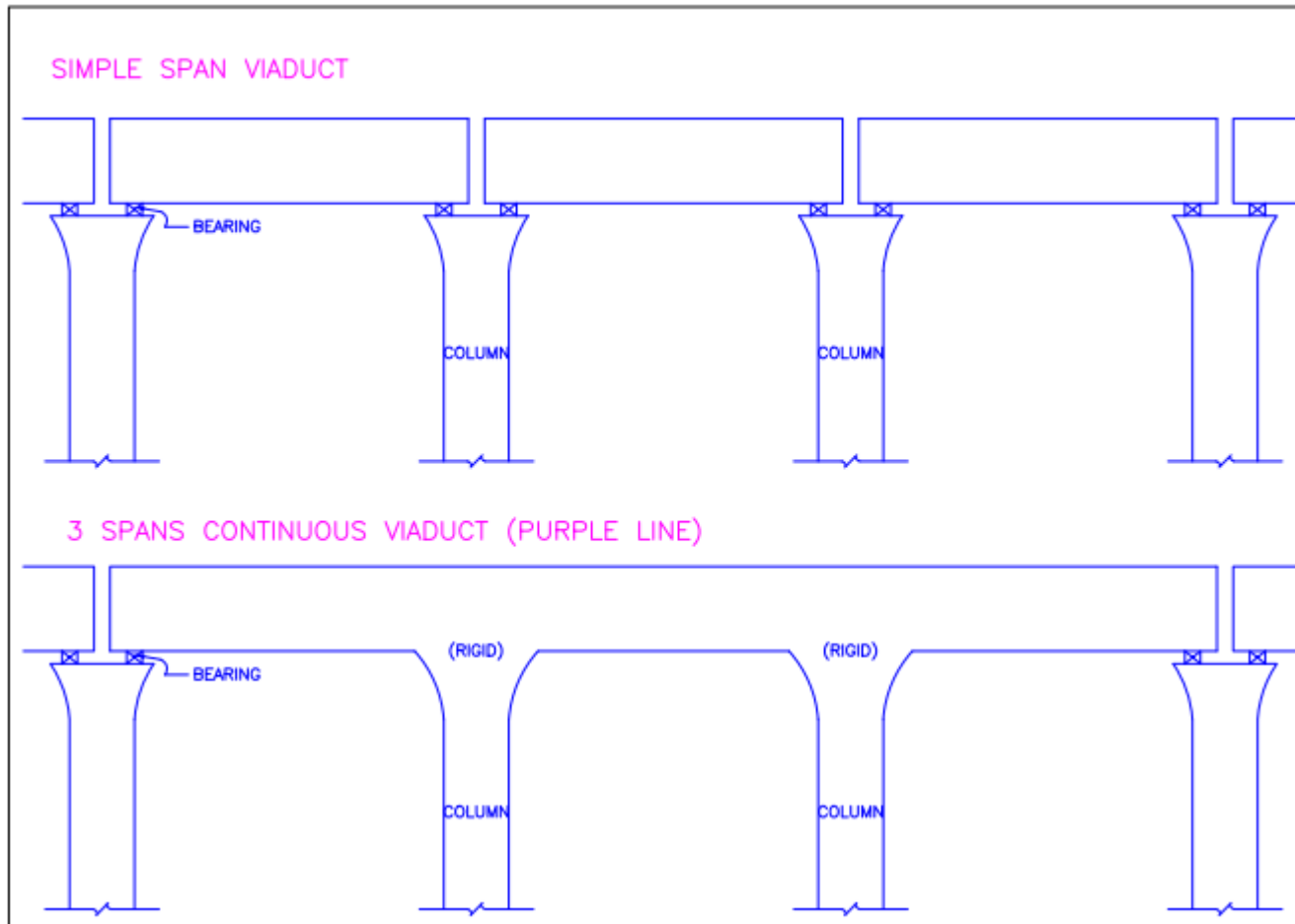



MRT Purple Line Project, Bang Yai – Bang Sue Section
Mass Rapid Transit Authority of Thailand, Ministry of Transport



SESSION 4: OVERALL SCHEDULE



MRT Purple Line Schedule

MRT Purple-Line Schedule

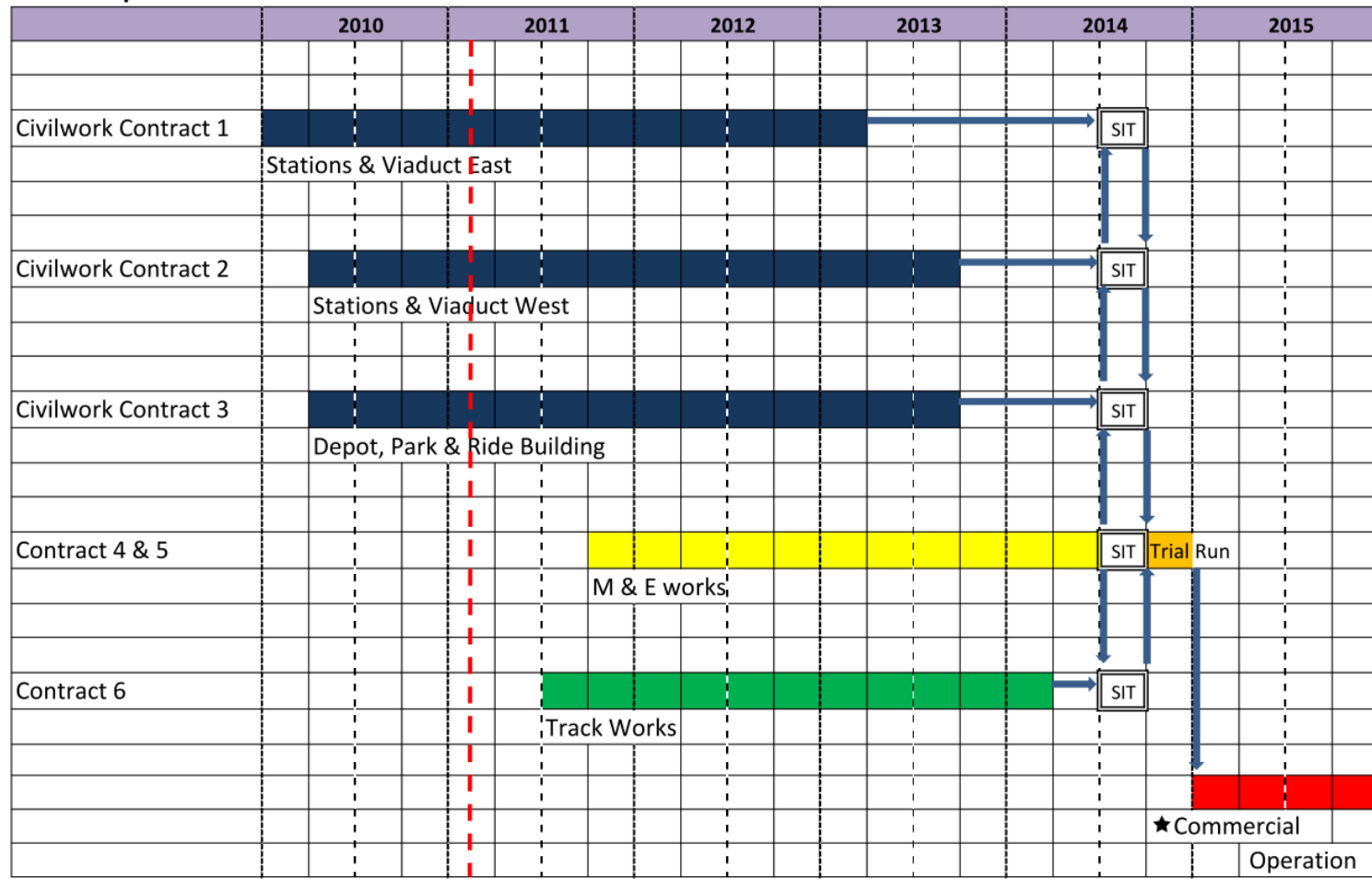



MRT Purple Line Project, Bang Yai - Bang Sue Section
Mass Rapid Transit Authority of Thailand, Ministry of Transport



THANK YOU
THANK YOU



MRTA

